

DM 160 DM 140 DM 120

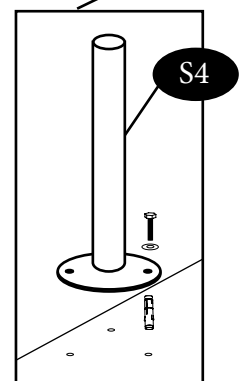

9	10	11	12	13	
1980	2200	2420	2640	2860	mm
-	-	-	-	-	
2142	2380	2618	2856	3094	mm
232°	258°	284°	310°	336°	
236°	262°	288°	314°	340°	
205°	228°	251°	273°	296°	

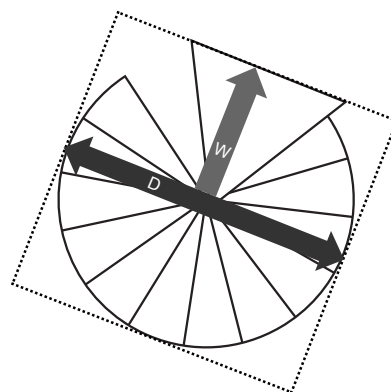

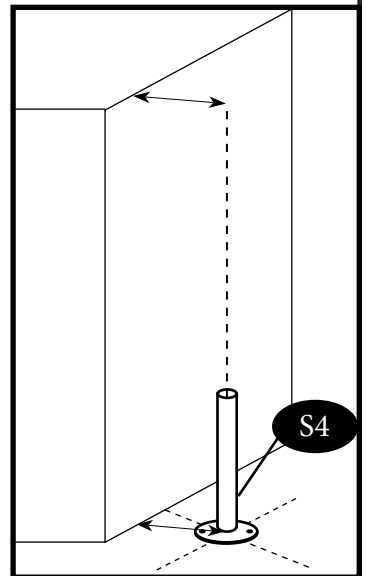
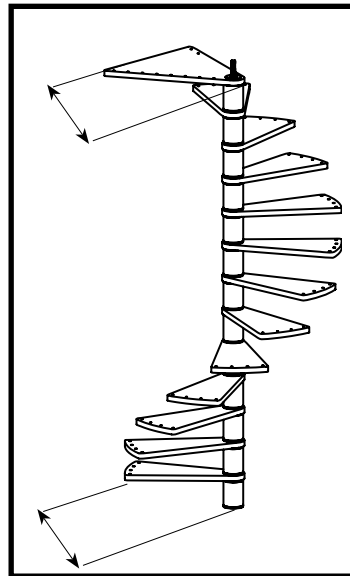
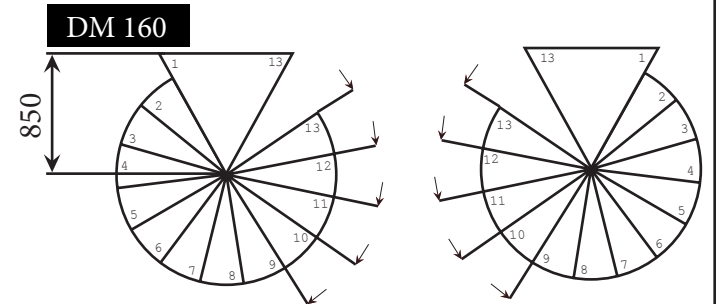
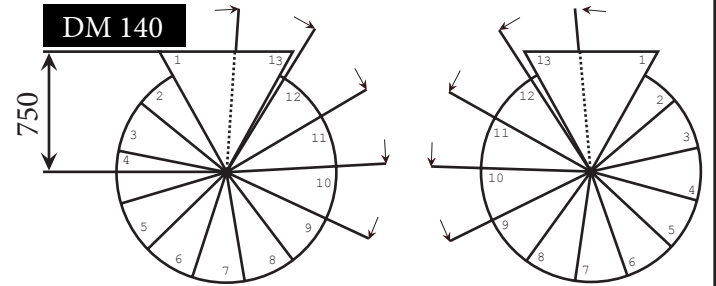
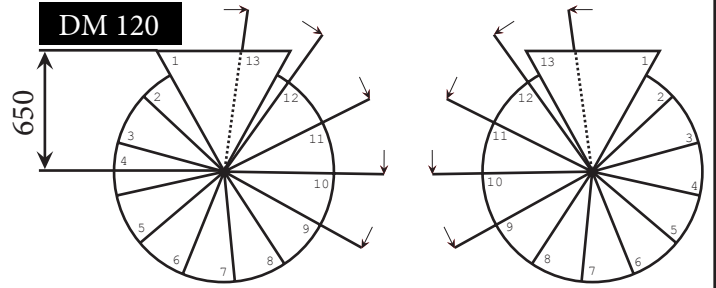
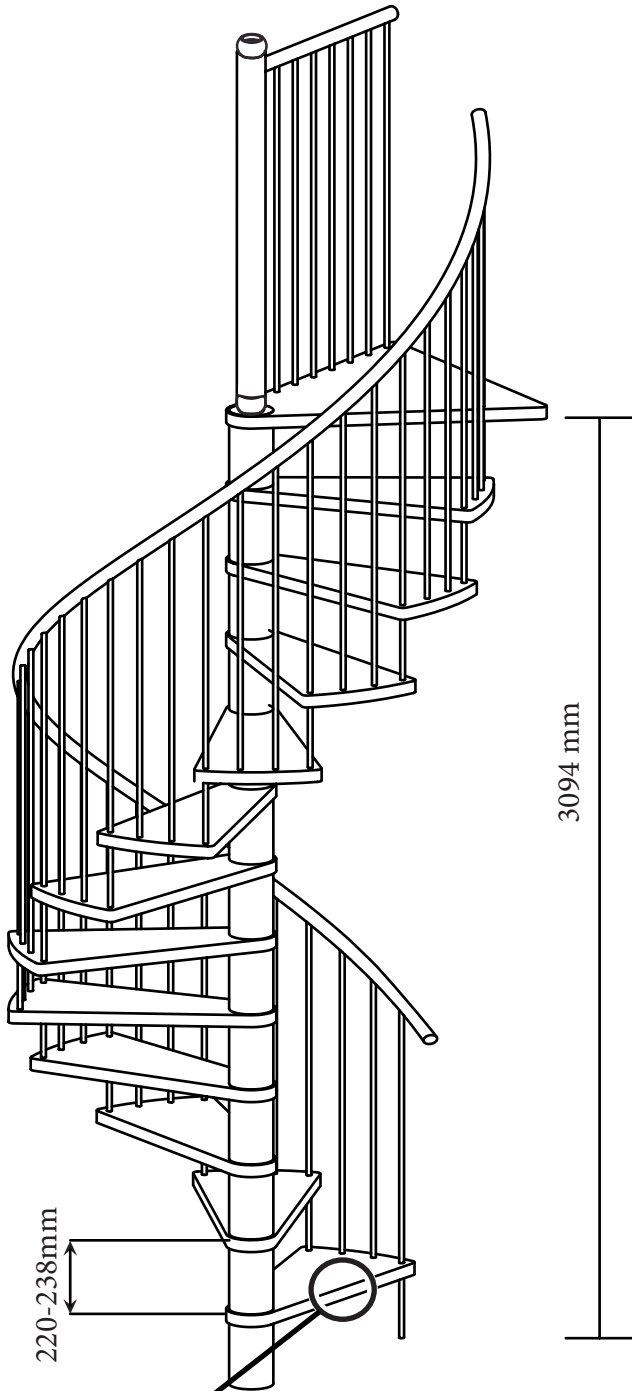



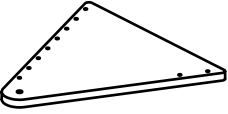
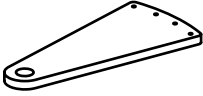
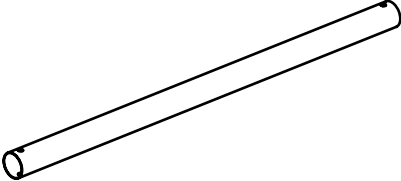
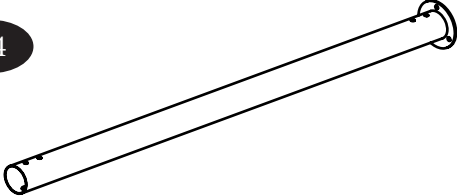
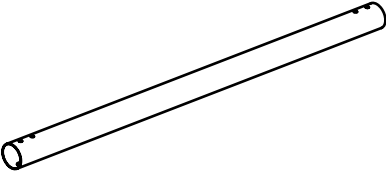
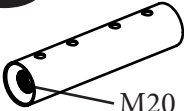
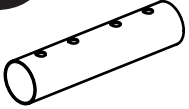
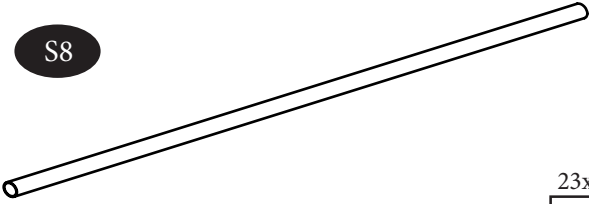

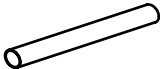
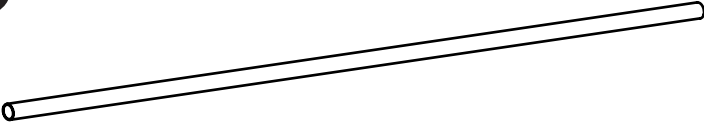
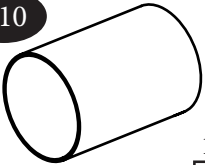
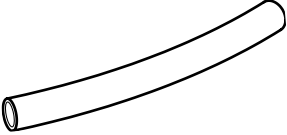
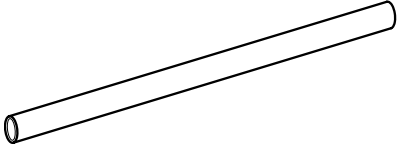
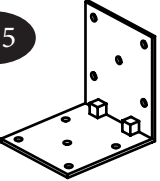
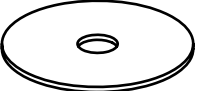
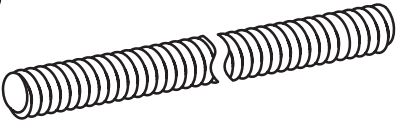



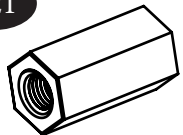

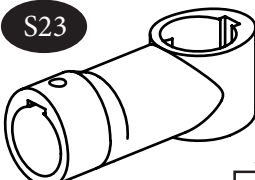
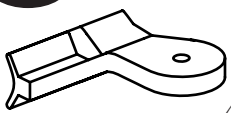

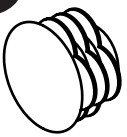
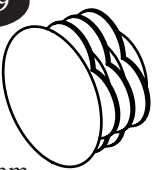



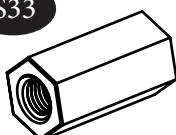

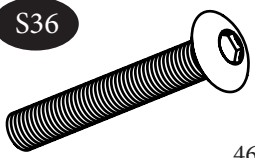
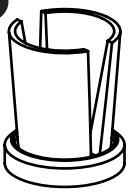
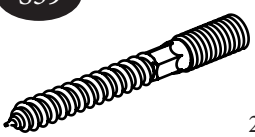
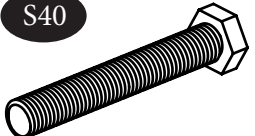
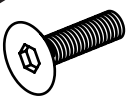

max. 200kg

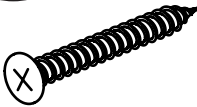
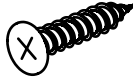

	W	D
120	600-650 mm	> 1200 mm
140	700-750 mm	> 1400 mm
160	800-850 mm	> 1600 mm

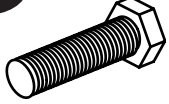
<p>S1</p>  <p>1x</p>	<p>S2</p>  <p>12x</p>	
<p>S3</p>  <p>910x50x1mm</p> <p>1x</p>	<p>S4</p>  <p>Ø60,2x1050mm</p> <p>1x</p>	
<p>S5</p>  <p>Ø60,2x1050mm</p> <p>1x</p>	<p>S6</p>  <p>M20</p> <p>Ø51x2,6x220mm</p> <p>1x</p>	<p>S7</p>  <p>Ø51x2,6x220mm</p> <p>1x</p>
<p>S8</p>  <p>Ø22x1x840mm</p> <p>23x</p>	<p>S11</p>  <p>Ø22x1x175mm</p> <p>14x</p>	<p>S12</p>  <p>Ø22x1x70mm</p> <p>1x</p>
<p>S9</p>  <p>Ø22x1x1100mm</p> <p>24x</p>		<p>S10</p>  <p>Ø127x2,9x179mm</p> <p>13x</p>
<p>S13</p>  <p>400x50x1mm</p> <p>12x</p>	<p>S14</p>  <p>952x50x1mm</p> <p>1x</p>	
<p>S15</p>  <p>90x90x80x3mm</p> <p>2x</p>	<p>S16</p>  <p>Ø100x3 d21mm</p> <p>1x</p>	<p>S17</p>  <p>M20 x 1000 mm</p> <p>2x</p>

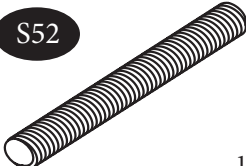
<p>S19</p>  <p>M8x1000mm</p> <p>6x</p>	<p>S20</p>  <p>M10x120mm</p> <p>1x</p>		
<p>S21</p>  <p>M20x60mm DIN6334</p> <p>1x</p>	<p>S22</p>  <p>Ø127x3mm</p> <p>104x</p>	<p>S23</p>  <p>3x</p>	<p>S24</p>  <p>46x</p>
<p>S25</p>  <p>Ø50mm</p> <p>17x</p>	<p>S26</p>  <p>46x</p>	<p>S27a</p>  <p>Ø8mm</p> <p>10x</p>	<p>S27b</p>  <p>Ø12mm</p> <p>2x</p>
<p>S28</p>  <p>Ø22mm</p> <p>1x</p>	<p>S29</p>  <p>Ø35mm</p> <p>5x</p>	<p>S30</p>  <p>M20 DIN934</p> <p>1x</p>	<p>S30a</p>  <p>M20 DIN439B</p> <p>1x</p>
<p>S31</p>  <p>M8 DIN434</p> <p>11x</p>	<p>S32</p>  <p>M5 DIN934</p> <p>46x</p>	<p>S33</p>  <p>M8DIN6334</p> <p>4x</p>	<p>S34</p>  <p>M6 DIN562</p> <p>6x</p>
<p>S35</p>  <p>M8x55mm</p> <p>3x</p>	<p>S36</p>  <p>M10x70mm</p> <p>46x</p>	<p>S37</p>  <p>M10</p> <p>50x</p>	<p>S38</p>  <p>74x</p>
<p>S39</p>  <p>M10x100mm</p> <p>2x</p>	<p>S40</p>  <p>M8x55mm DIN933</p> <p>3x</p>	<p>S41</p>  <p>M8x55mm DIN6912</p> <p>6x</p>	<p>S42</p>  <p>M5x20mm DIN7991</p> <p>46x</p>

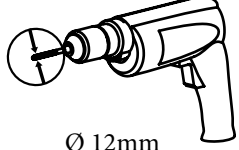
<p>S43</p>  <p>M6x6mm DIN914</p> <p>6x</p>	<p>S44</p>  <p>Ø6x50mm</p> <p>10x</p>	<p>S45</p>  <p>Ø6x30mm</p> <p>10x</p>	<p>S46</p>  <p>Ø3,9x19mm</p> <p>92x</p>
<p>S47</p>  <p>Ø30x3mm</p> <p>124x</p>	<p>S48</p>  <p>Ø16mm</p> <p>3x</p>	<p>S49</p>  <p>8x</p>	<p>S50</p>  <p>M8x14mm</p> <p>1x</p>
<p>S51</p>  <p>Ø4x25mm</p> <p>46x</p>	<p>S52</p>  <p>M10x300mm</p> <p>12x</p>	<p>S53</p>  <p>M10x35mm</p> <p>12x</p>	 <p>Ø 12mm Ø 8mm Ø 1,5mm</p>

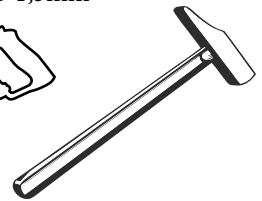
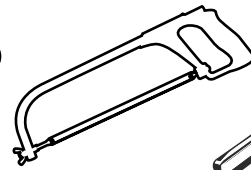
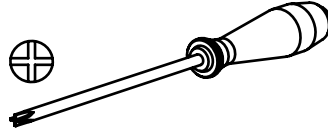
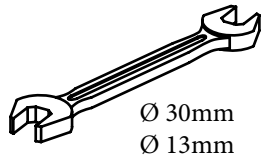
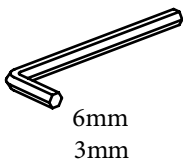

1

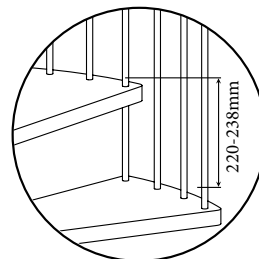
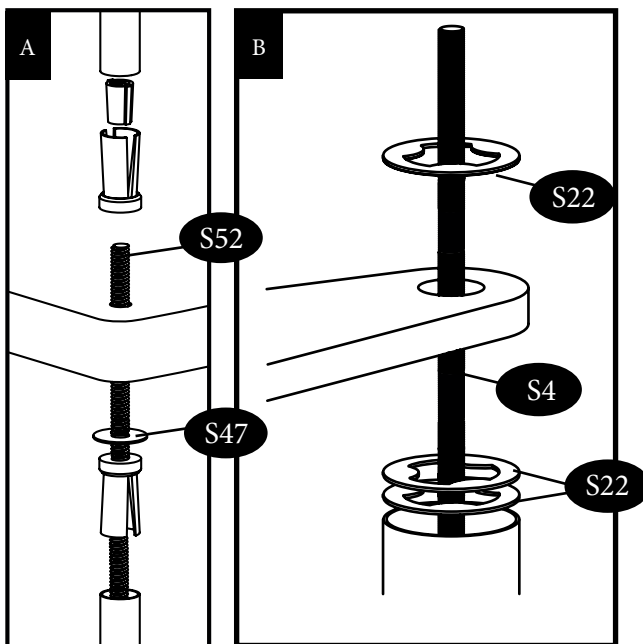

A

- 0 x S47 = 220 mm
- 1 x S47 = 223 mm
- 2 x S47 = 226 mm
- 3 x S47 = 229 mm
- 4 x S47 = 232 mm
- 5 x S47 = 235 mm
- 6 x S47 = 238 mm

B

- 2 x S22 = 220 mm
- 3 x S22 = 223 mm
- 4 x S22 = 226 mm
- 5 x S22 = 229 mm
- 6 x S22 = 232 mm
- 7 x S22 = 235 mm
- 8 x S22 = 238 mm

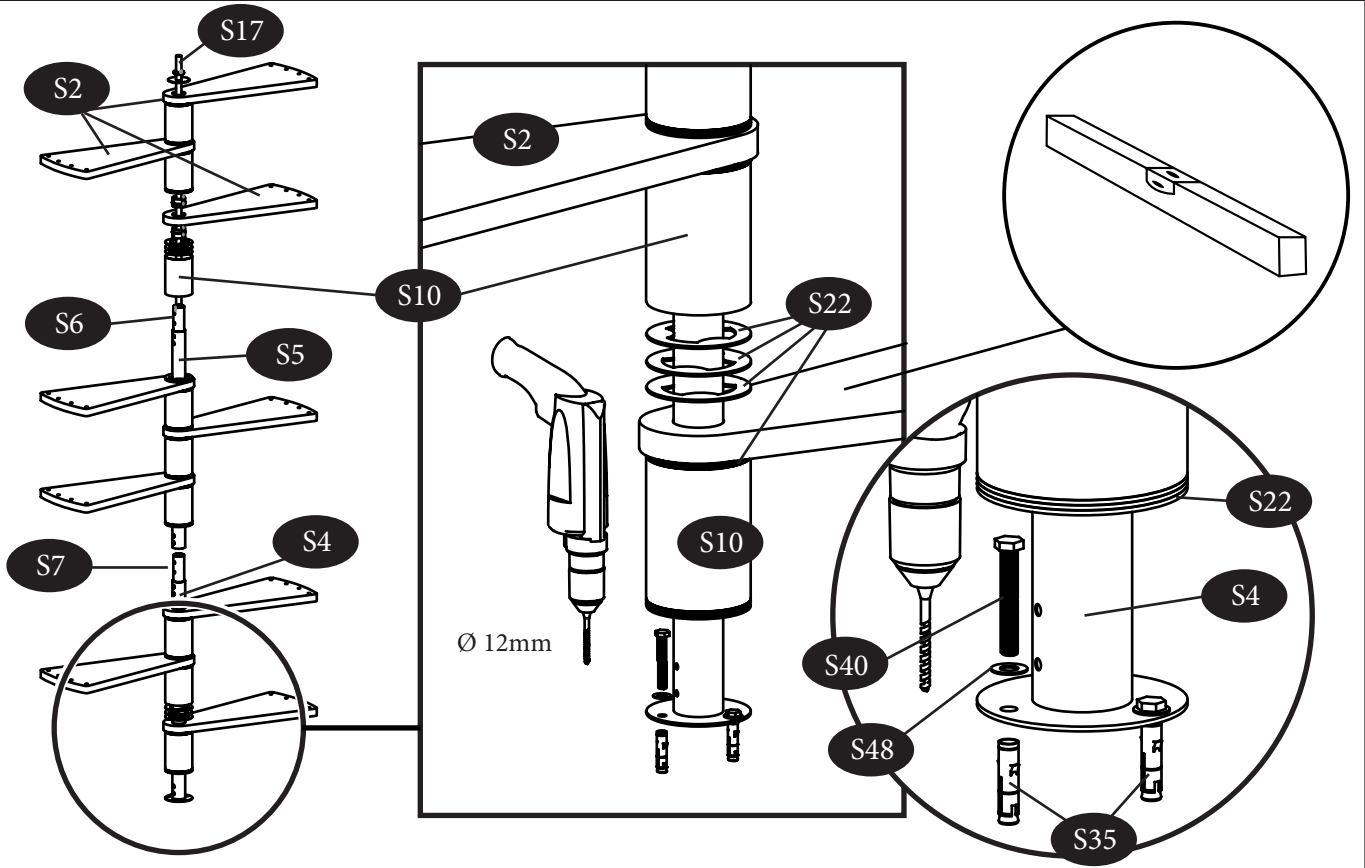

2

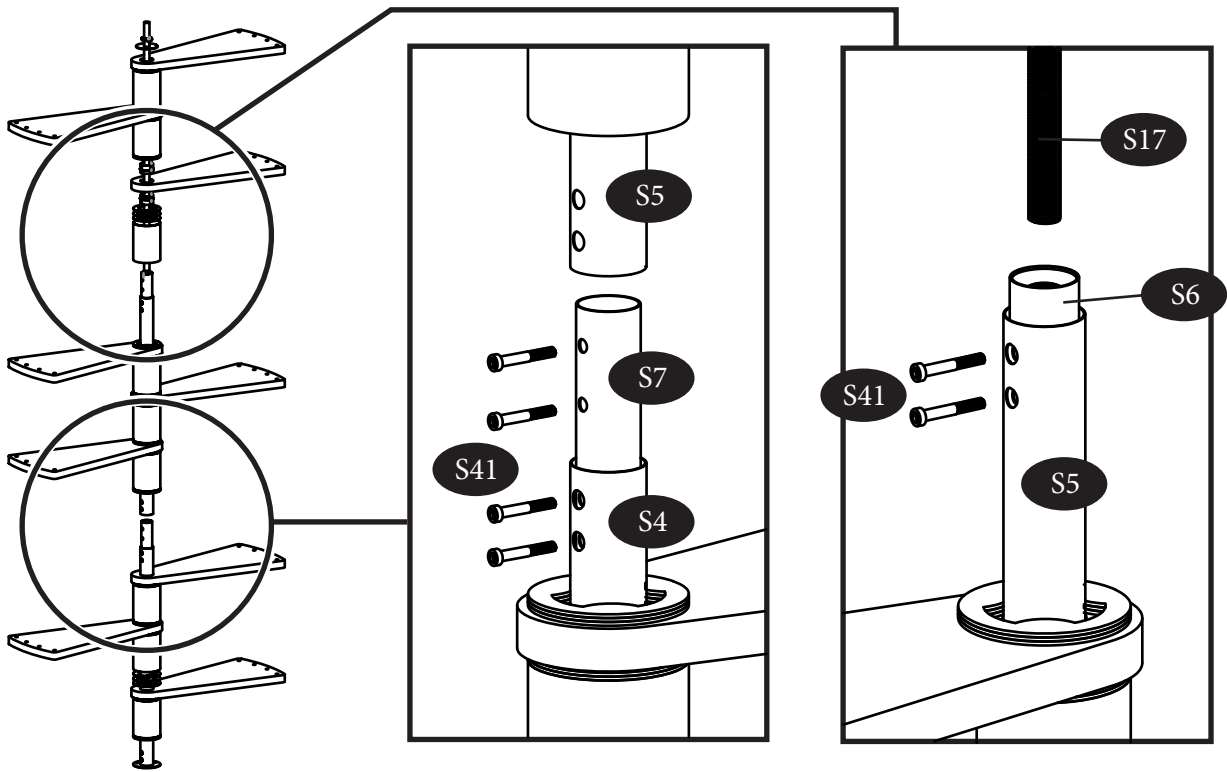

3

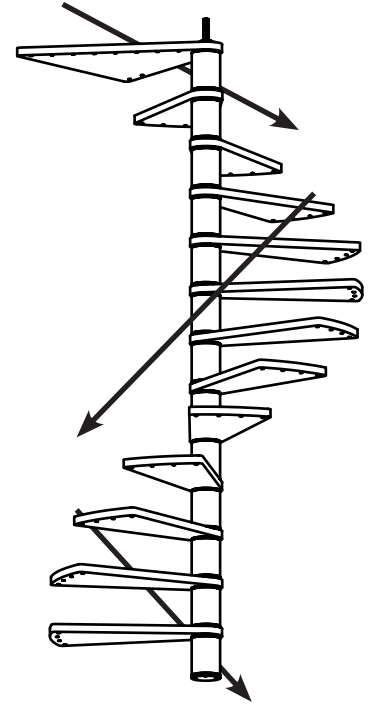
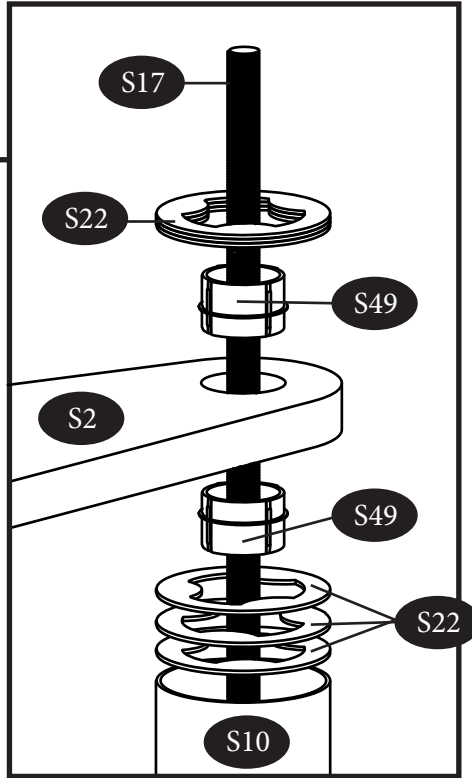
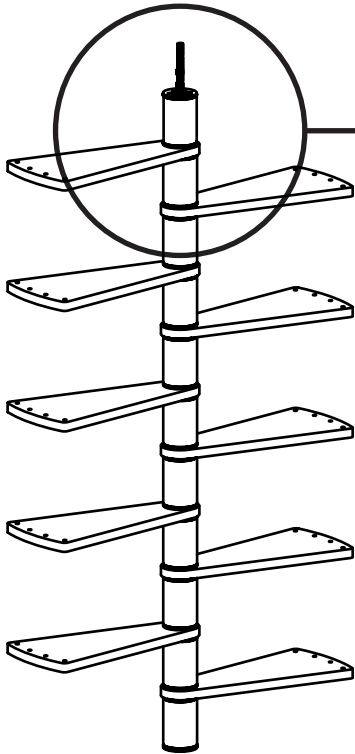

4

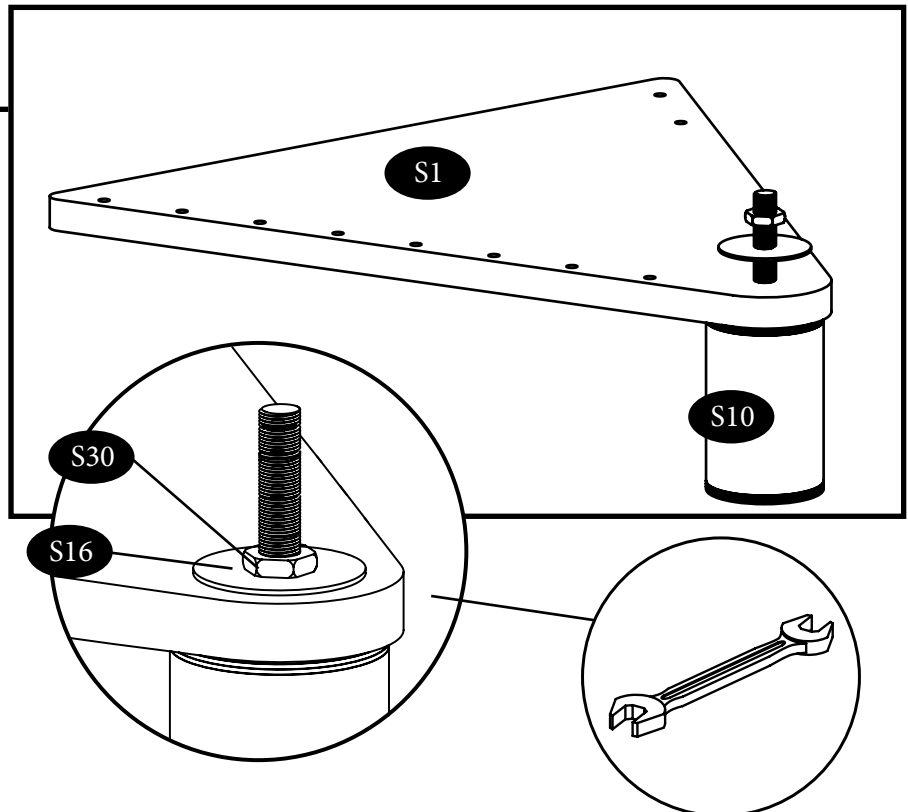
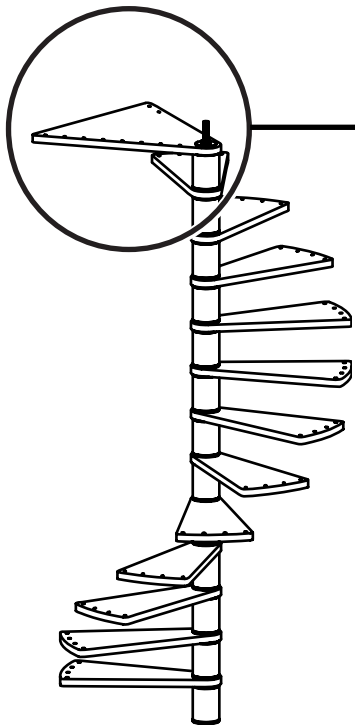

5

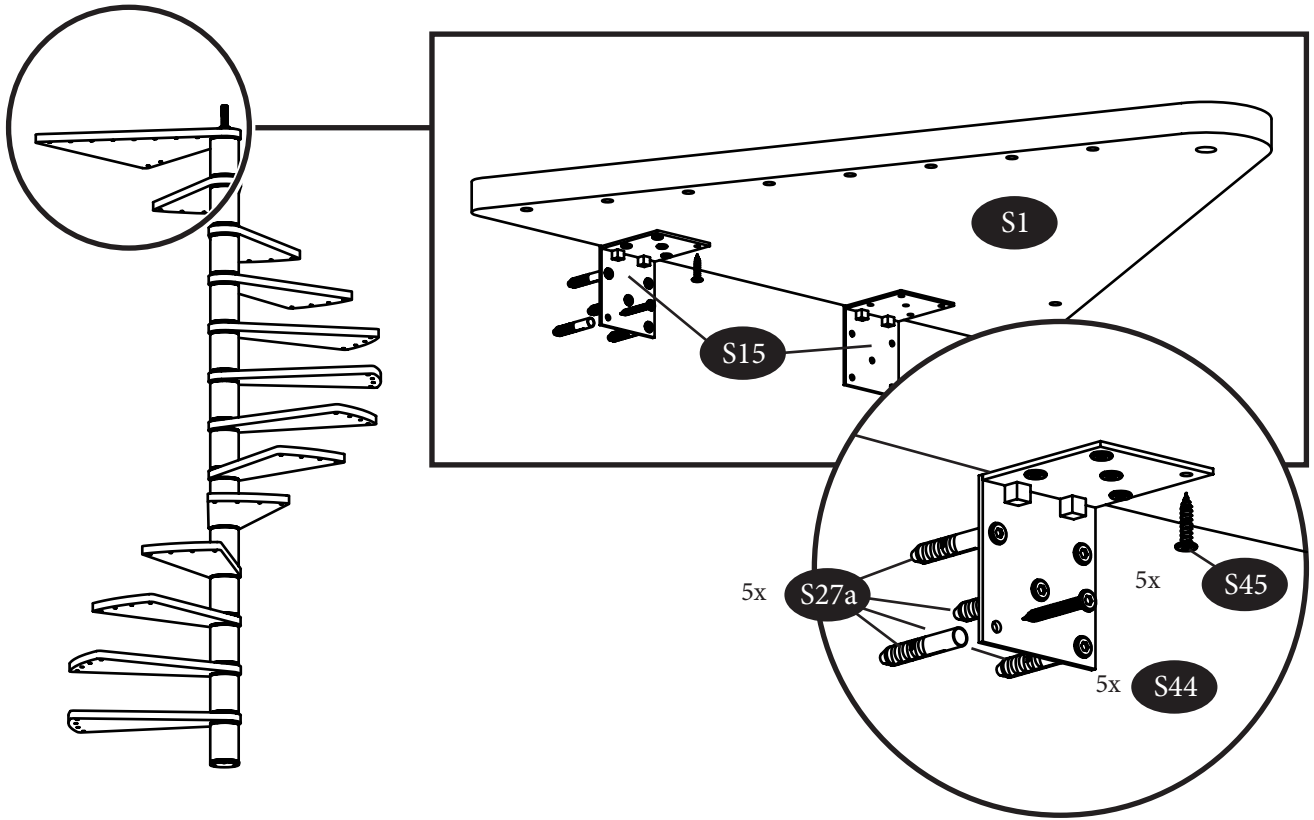

6

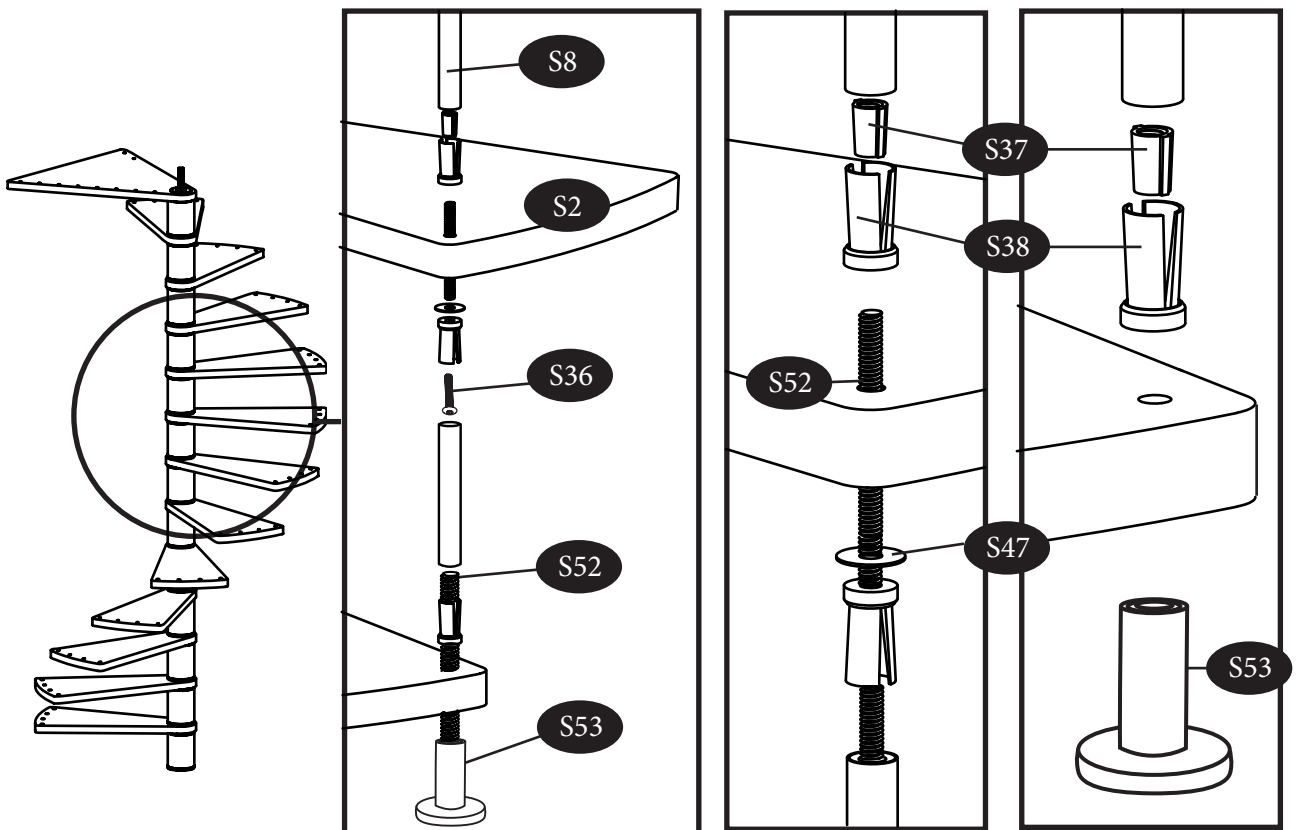

7

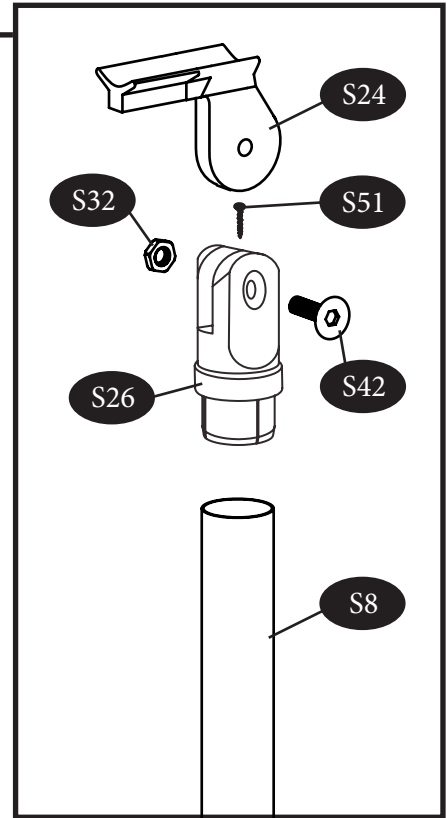
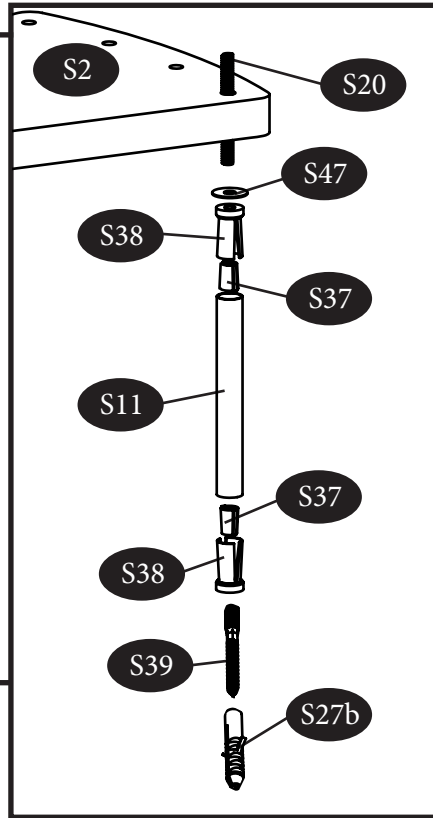
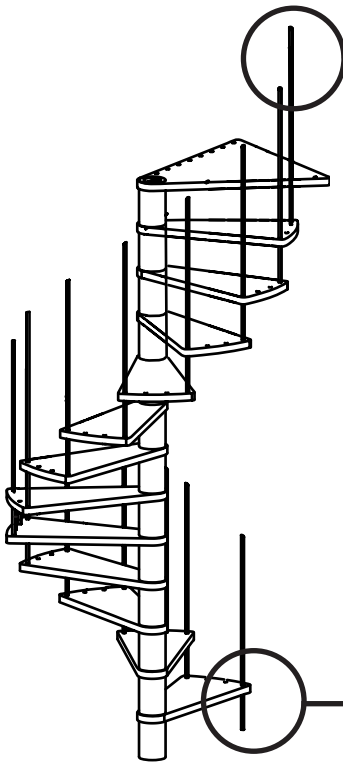

8

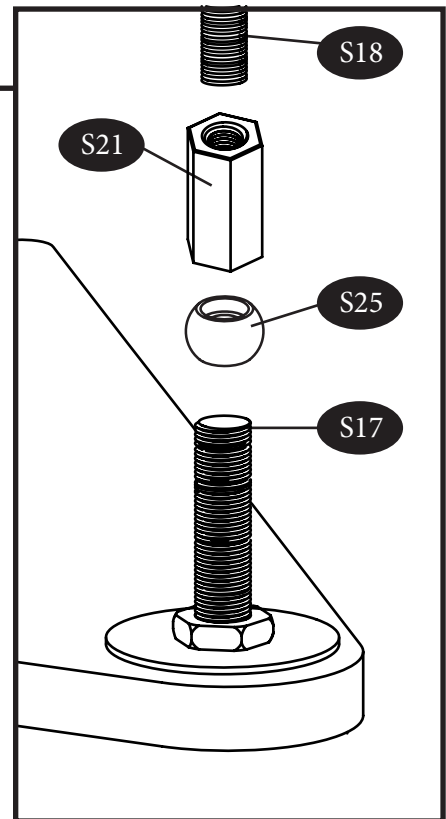
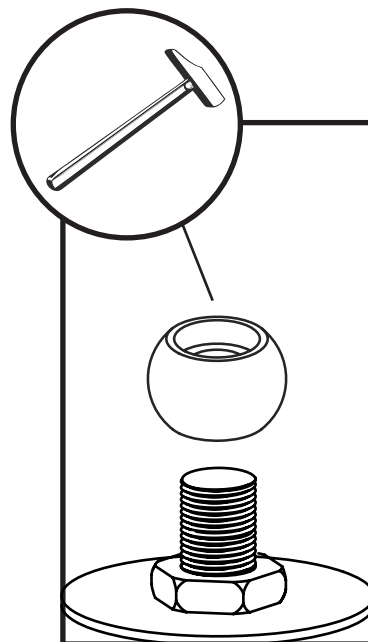
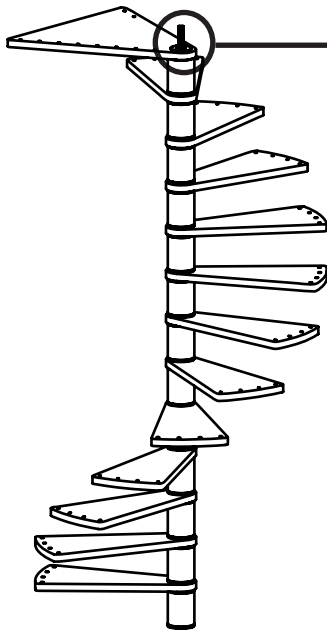

9

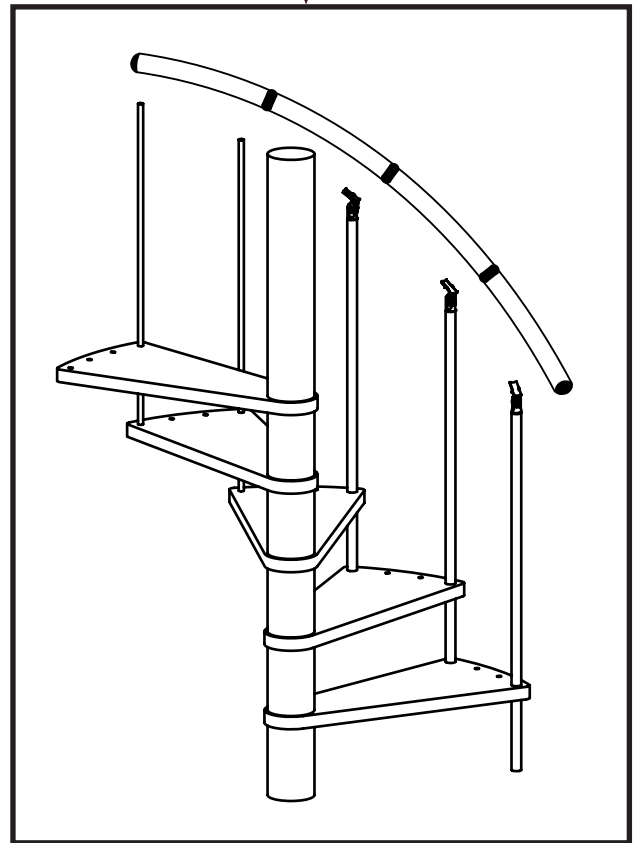
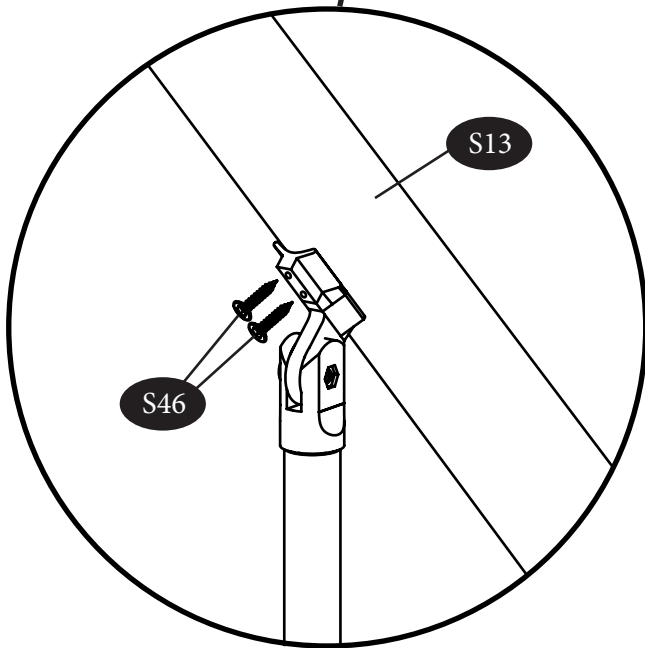
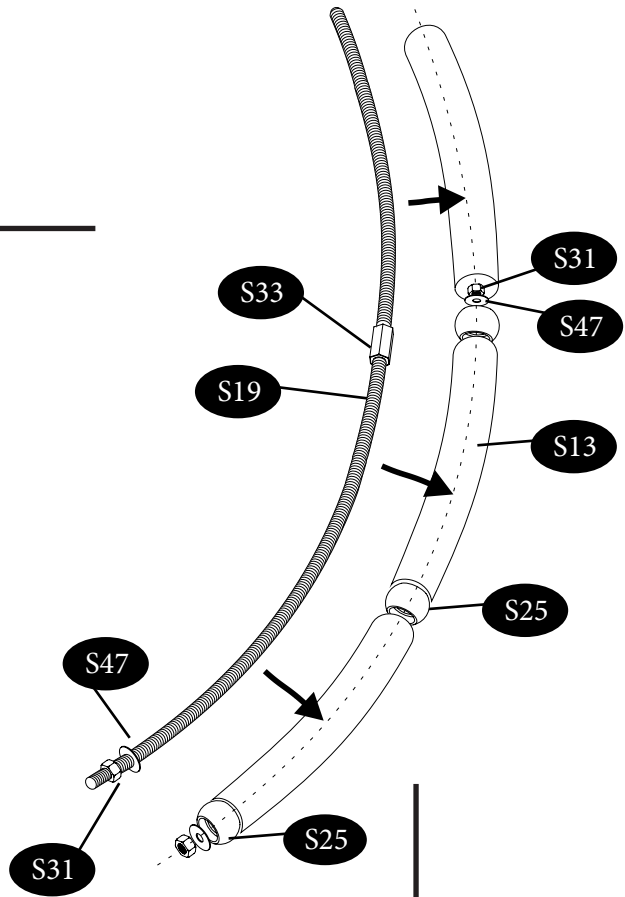
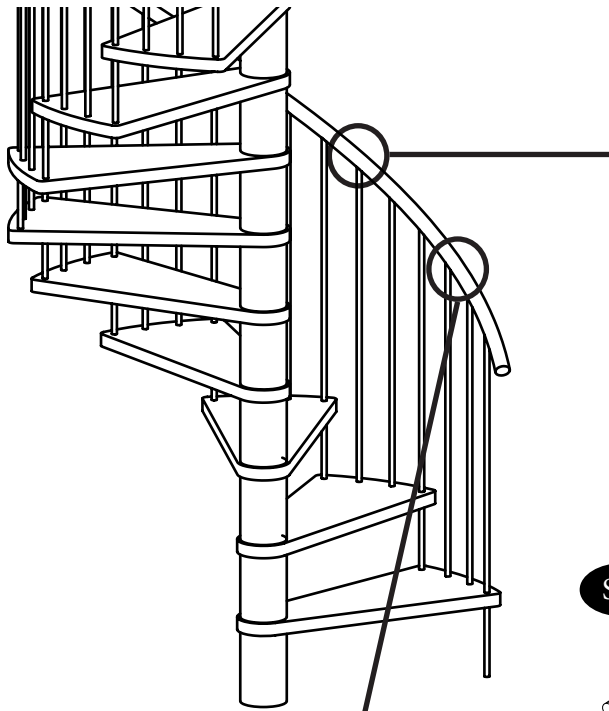

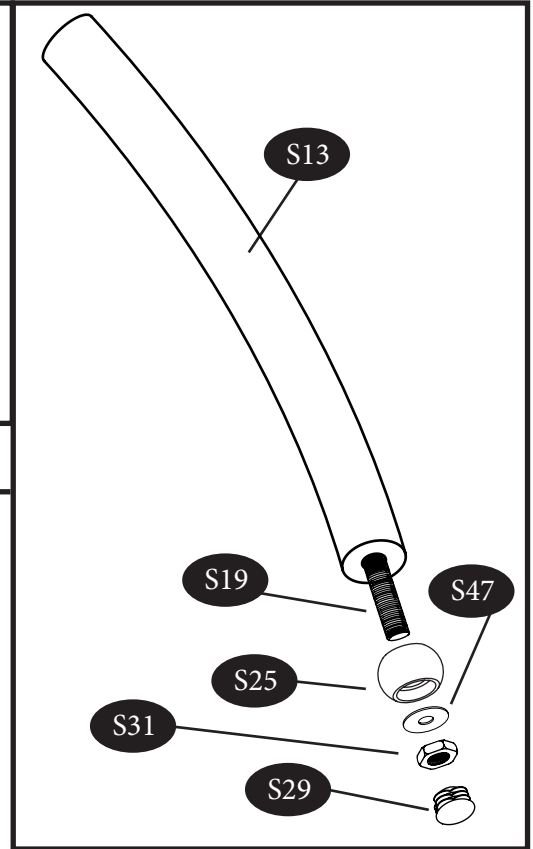
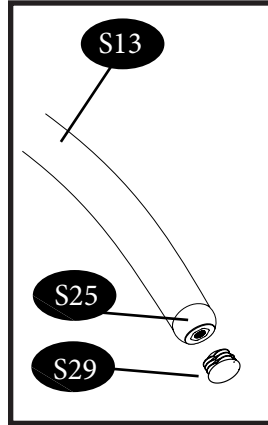
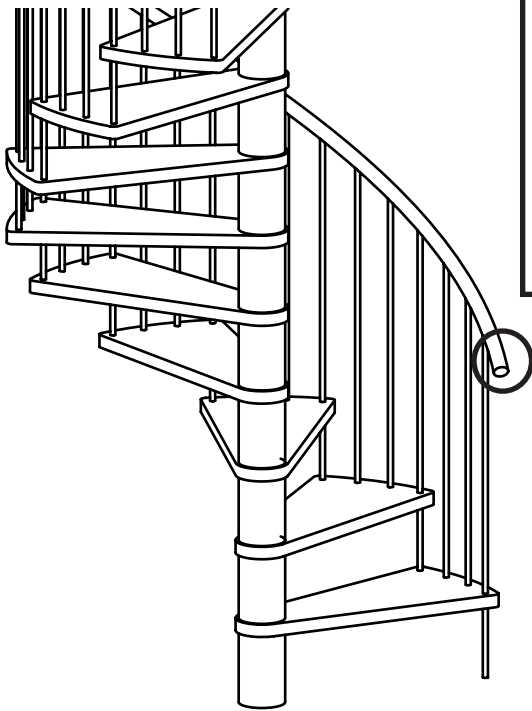

11

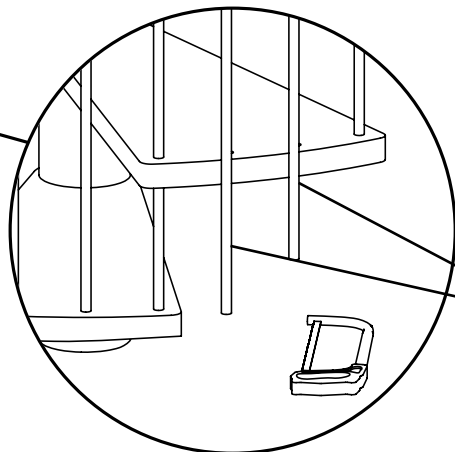
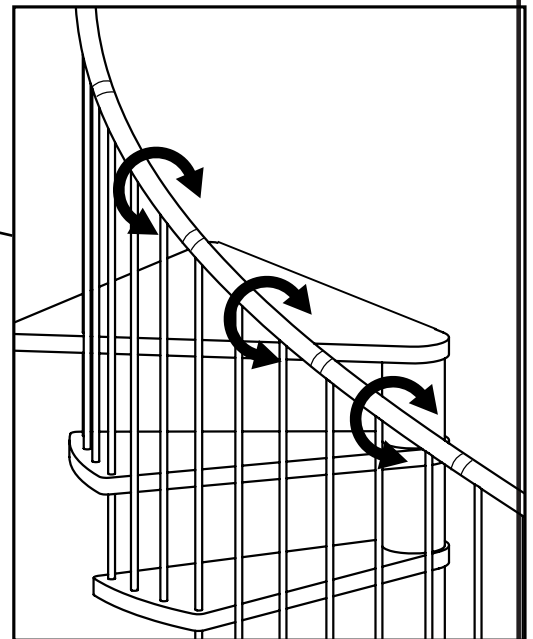
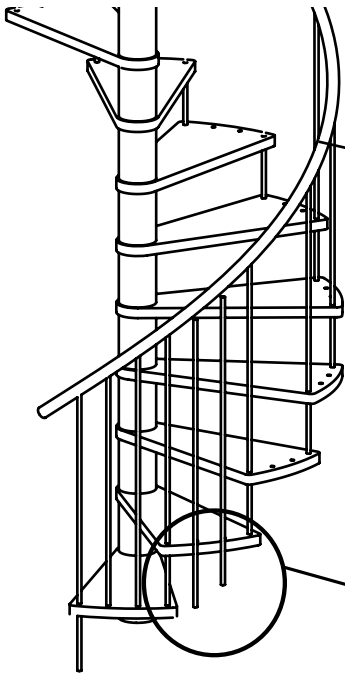

S9

12

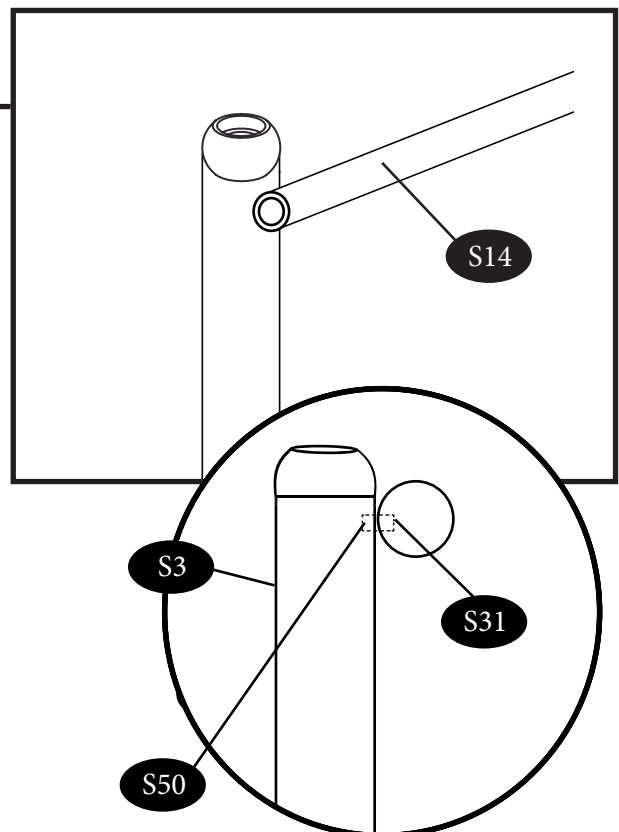
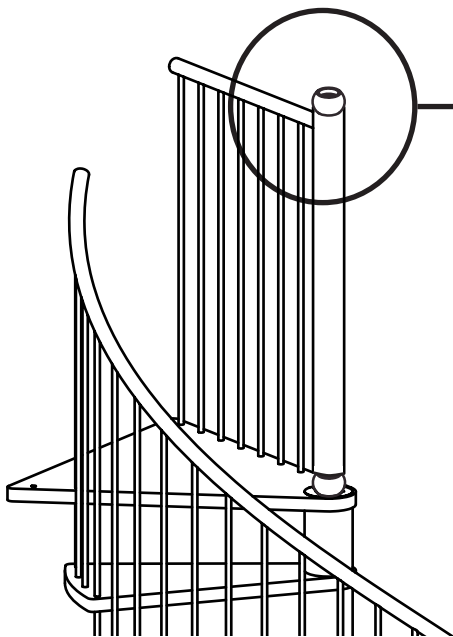
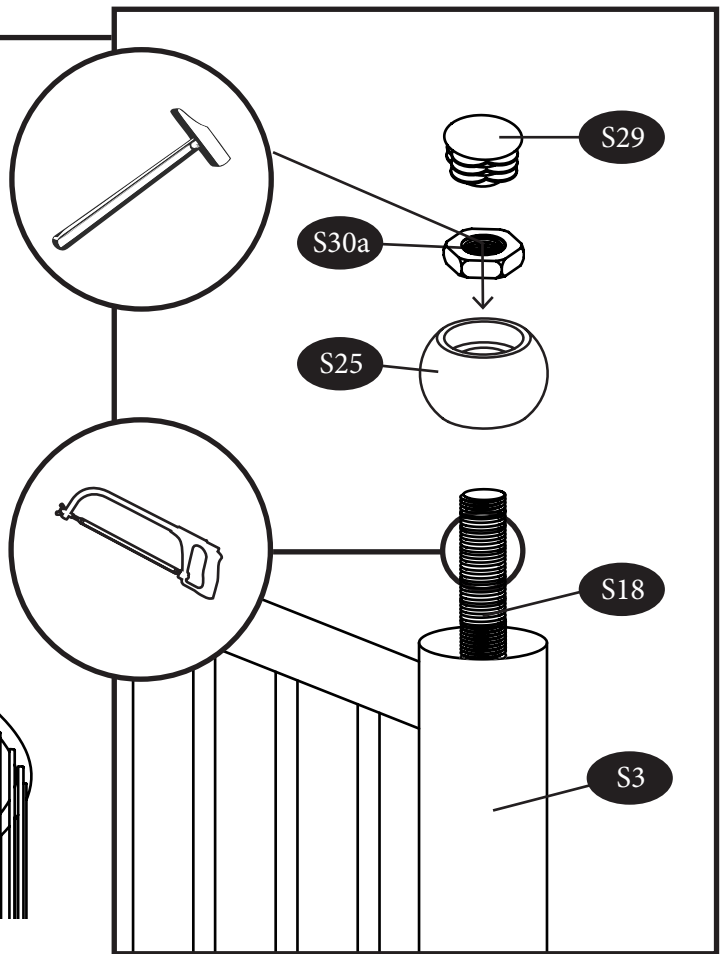
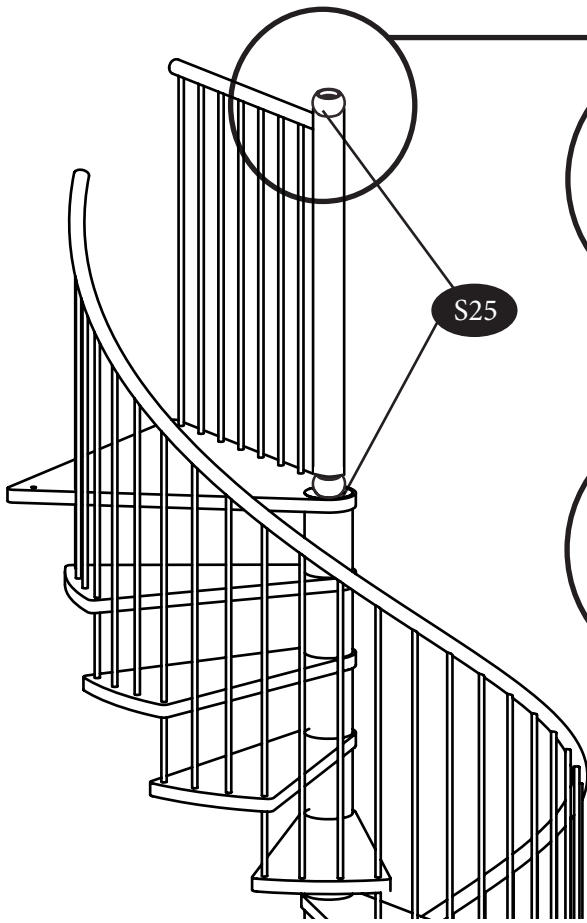

13

